

Identify your model, read instructions and review illustrations carefully prior to maintenance.

STEP 1: MODEL 2200 – TO REMOVE INNER ASSEMBLY.

- A. Turn off furnace blower.
- B. Remove access door.
- C. Slide out inner assembly.



MODEL 2250 – TO REMOVE GRILLE ASSEMBLY.

- A. Turn off blower.
- B. Loosen two knobs on grille (they remain attached).
- C. Pull out grille assembly until spring clips engage.
- D. Compress spring clips and remove grille assembly.

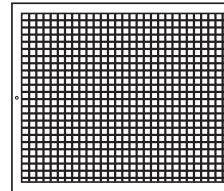

STEP 2: Before proceeding, determine which style Aprilaire® inner housing you have.

If your inner housing has a center aluminum brace as shown here and black holding brackets, then follow the instructions below and Figures 1-3.

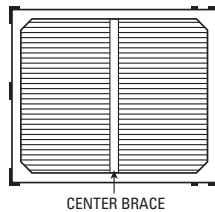

If your inner housing does not have a center aluminum brace as shown here and is equipped with hinged brackets, then follow the instructions below and Figures 4-6.

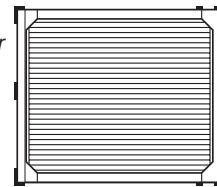

STEP 3: To remove media, see Figures 1-3.

- A. Place inner assembly so that all pleat spacers (Figure 1F) are up. Open both end panels (Figure 1A), by unsnapping side latches (Figure 1B).
- B. Remove pleat spacers from black holding brackets (Figure 1F) by lifting and tilting both ends at the same time.
- C. Remove black holding brackets (Figure 2E).
- D. On side farthest away, lift cardboard flap clear (Figure 3C). Compress media, lift to remove from near side and discard properly.

STEP 3: To remove media, see Figures 4-6.

- A. Place inner assembly so that all pleat spacers (Figure 4F) are up. Open both end panels (Figure 4A), by unsnapping side latches (Figure 4B).
- B. Remove all pleat spacers from hinged brackets (Figure 4F) by lifting and tilting both ends at the same time.
- C. Open hinged brackets (Figure 5E) by lifting along entire inner edge.
- D. On side farthest away, lift cardboard flap clear (Figure 6C). Compress media, lift to remove from near side and discard properly.

STEP 4: To install media, see Figures 1-3. This media is special material and should be handled very carefully to avoid any damage that would affect its performance.

- A. Place one cardboard flap (Figure 3C) over the flange (Figure 3G) on the side farthest away. Expand media (Figure 3D) towards you and place other cardboard flap over the flange on the near side. Be sure media is centered over the opening in the inner assembly.
- B. Place black holding brackets (Figure 2E) over cardboard flaps (Figure 3C) as shown in Figure 2.
- C. Carefully place one pleat spacer finger into each pleat starting at either end next to the alignment yarn. The ends of the pleat spacers align with notches in the black holding brackets and snap into place.
- D. Close end panels (Figure 1A) and snap side latches closed (Figure 1B).

STEP 4: To install media, see Figures 4-6. This media is special material and should be handled very carefully to avoid any damage that would affect its performance.

- A. Place one cardboard flap (Figure 6C) over the hooks and through the slots of the flap (Figure 6G) on the side farthest away. Expand media (Figure 6D) towards you and place other cardboard flap over the hooks and through the slots on the near side. Be sure media is centered over the opening in the inner assembly.
- B. Close hinged brackets (Figure 5E) over cardboard flaps (Figure 6C) centered on sides as shown in Figure 5. Press firmly along entire edge of both brackets so brackets snap into place.
- C. Carefully place one pleat spacer finger into each pleat starting at either end next to the alignment yarn. The ends of the pleat spacers align with notches in the hinged brackets and snap into place.
- D. Close end panels (Figure 4A) and snap side latches closed (Figure 4B).

Instructions for units with black holding brackets and center aluminum brace on intake side, see Figures 1-3.

Instructions for units with hinged brackets without center aluminum brace on intake side, see Figures 4-6.

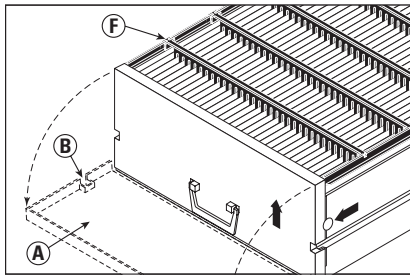

Figure 1

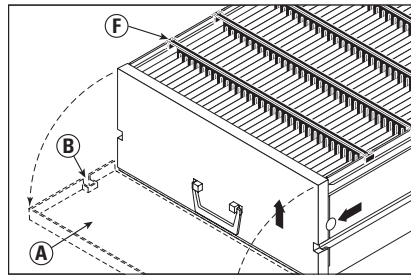

Figure 4

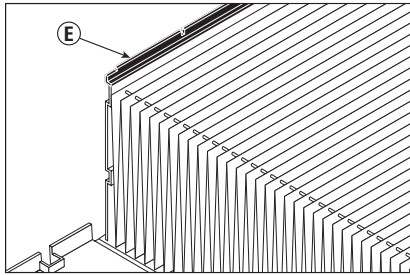

Figure 2

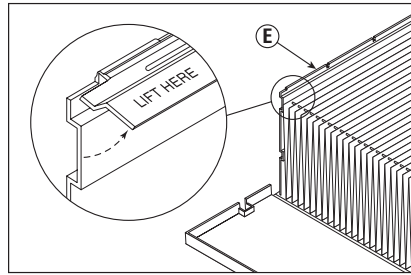

Figure 5

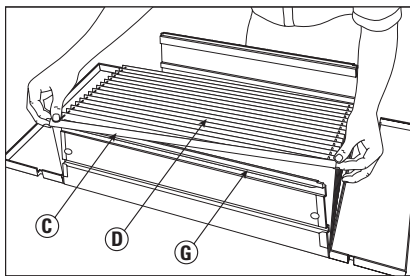

Figure 3

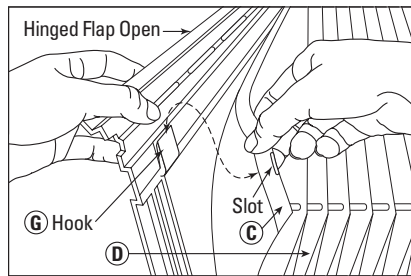

Figure 6

STEP 5: MODEL 2200 – TO RE-INSTALL INNER ASSEMBLY.

- A. Slide inner assembly into outer housing.
- B. Replace access door.
- C. Turn on furnace blower.

MODEL 2250 – TO RE-INSTALL GRILLE ASSEMBLY.

- A. Slightly compress spring clips and slide grille assembly into opening.
- B. Release pressure on spring clips and allow clips to catch.
- C. Hold unit firm to wall or ceiling and tighten two knobs.
- D. Turn on blower.

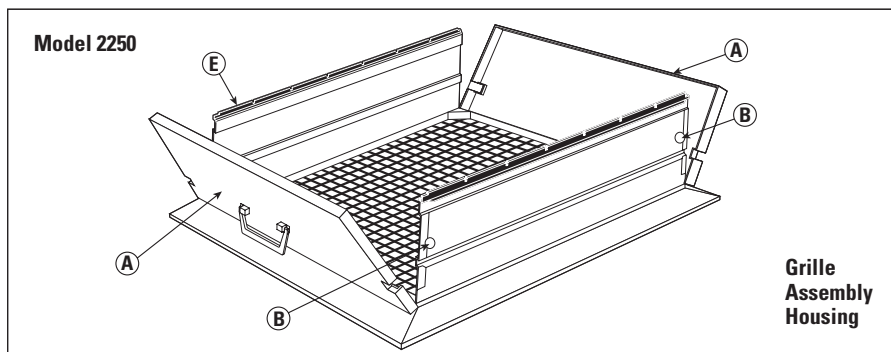

Grille Assembly Housing